

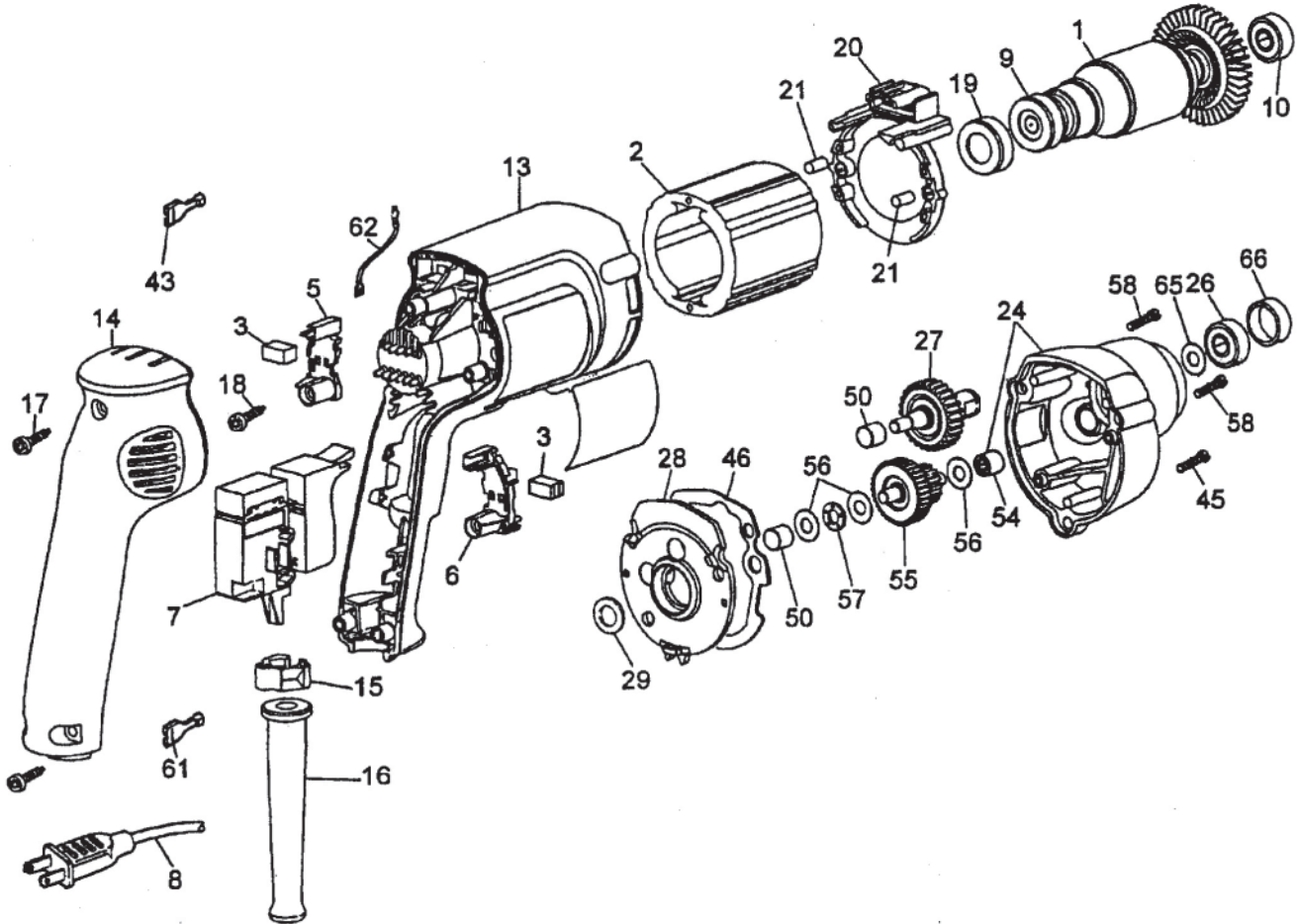

Component Motor Unit Model 253-59

Used on KD-440, KD-441, KD-442, KD-493 and KD-495 Shears
 KS-423, KS-424, KS-426 and KSV-432 Saws

PARTS LIST



ITEM NO.	PART NO.	DESCRIPTION	REQ'D TOOL	ITEM NO.	PART NO.	DESCRIPTION	REQ'D TOOL
1	382299-01	Armature & Fan (6 Teeth)	1	*54	93129-00	Needle Bearing	1
2	176883-00	Field	1	55	176731-00	Pinion & Gear (15/37 teeth)	1
3	176846-02	Brush	2	56	176732-00	Thrust Washer	3
5	176801-02	Left Brush Holder (gray)	1	57	143079-00	Thrust Washer	1
6	176800-02	Right Brush Holder (black)	1	*58	330019-16	Screw	2
7	176830-39	Switch	1	61	136086-08	Terminal	2
*8	330072-98	Cord & Plug (18-2SJ)	1	62	176860-00	Lead	1
*9	176950-00	Ball Bearing	1	65	449892-00	Washer	1
*10	176950-00	Ball Bearing	1	66	449368-00	Bearing Cap	1
13	396969-09	Field Case	1	*NOTES: 8, 15 Cord clamp should be positioned, so that 30mm of cord jacket extends above the clamp. 9 Seal to face commutator. Press to the tubing on armature shaft. 10 To remove from shaft, place bearing in vise and crush outer race. Remove all internal bearing components, so that the inner race is all that is left. Use SRT320, Small Bearing Separator, to clamp the inner race and press off. Bearing presses to shoulder. 17,45,58 Torque to 18-23 inch-lbs. 18 Torque to 13 inch-lbs. 19 Small diameter end to face commutator. Lightly lubricate before installing into field case. 26 Press Bearing until seated completely in pocket. Rubber seal to face spindle and gear assembly. 28 Includes 10 and 50. 29 Press to bearing (item 10). 54 Press flush with surface facing spindle and gear assembly.			
14	176899-02	Handle Cover	1				
*15	176829-00	Cord Clamp	1				
16	330005-01	Cord Protector	1				
*17	330019-13	Screw	3				
*18	176951-00	Screw	2				
*19	389824-00	Cup	1				
20	176811-01	Baffle	1				
21	949638-02	Rubber Plug	2				
*24	388657-00	Gear Case	1				
*26	330003-09	Ball Bearing	1				
27	388668-00	Spindle & Gear	1				
*28	176650-00	Gear Case Cover	1				
*29	23813-00	Fiber Washer	1				
43	136086-02	Terminal	4				
*45	330019-14	Screw	1				
46	176655-00	Gasket	1				
*50	93128-00	Needle Bearing	2				



INSTRUCTIONS FOR THE CARE OF THE KETT 95-20 SHEAR HEAD

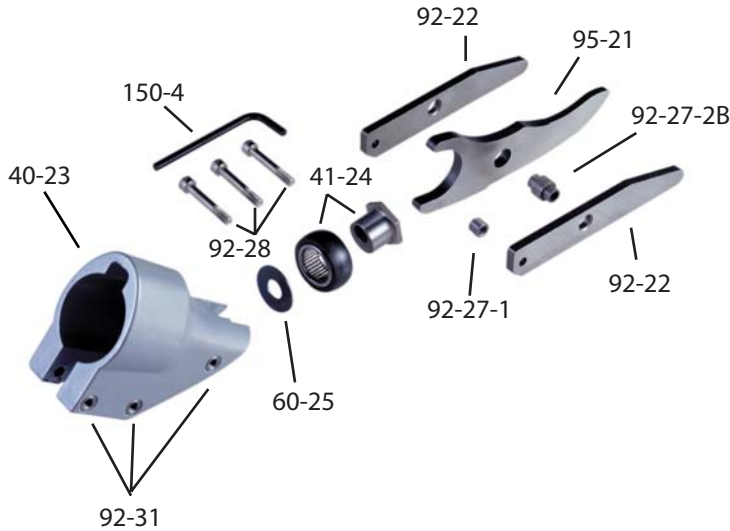

CAUTION

**Disconnect Power Unit
Before Servicing Tool**

PARTS LIST

95-21	Center Blade
92-22	Side Knife (2)
40-23	Shear Housing
41-24	Eccentric Bearing Assembly
92-27-2B	Spacer Bushing
92-27-1	Spacer Bushing
92-28	Cap Screw (3)
92-31	Knurled Insert (3)
60-25	Thin Washer, Large
150-4	Allen Wrench

DISASSEMBLY: To remove the shear head from the motor loosen three cap screws (92-28). Remove shear head from motor by pulling head firmly forward. Slight tapping with a mallet may be required if head does not slide off easily.

To remove cutter blades from shear head remove three cap screws (92-28) from shear housing (40-23). Be careful not to lose rear spacer bushing (92-27-1) when removing the middle cap screw. Remove center blade (95-21) from shear housing by tapping blade gently rearward. Be careful not to lose spacer bushing (92-27-2B) from hole in center blade. Side knives (92-22) will now drop out of the shear housing.

To remove eccentric bearing assembly (41-24) from shaft use an appropriate wrench to loosen eccentric nut by turning counter clockwise.

ASSEMBLY: To install eccentric bearing assembly (41-24) onto shaft, make sure the large thin washer (60-25) is first inserted over the shaft. Screw eccentric bearing assembly on to shaft and tighten with appropriate wrench. Lubricate bearing with a good grade of bearing grease.

To install cutter blades into shear housing (40-23) place the side knives (92-22) into position in the

shear housing (40-23). Insert center cap screw (92-28) through the side knives (92-22) with rear spacer bushing (92-27-1) between them and start cap screw into thread just enough to hold blades in place. **DO NOT TIGHTEN.** Insert spacer bushing (92-27-2B) into hole in center blade (95-21) and lubricate with Molybdenum Disulfide grease (264-2) or equivalent. Install center blade into shear housing by tapping blade gently forward using a drift to line up hole in center blade with forward holes in housing. Insert and tighten forward cap screw (92-28) making sure spacer bushing (92-27-2B) in center blade stays in position. Apply Molybdenum Disulfide grease (264-2) or equivalent to clevis or yoke in center blade where it rides on the eccentric bearing assembly. Insert rear cap screw (92-28) into shear housing, but do not completely tighten.

To install shear head assembly onto drive motor make sure all cap screws (92-28) are loosened about three or four complete turns. Spread shear housing (40-23) slightly using a spreader (drift) near the rear cap screw (92-28). Place shear head onto unit, tap left side knife rearward as far as it will go, and tighten cap screws to 40-45 inch pounds. It may be necessary to gently tap the shear head into place if it does not readily slip onto the nose of the power unit.

WARNING: THE KETT TOOL CO. CANNOT ASSUME RESPONSIBILITY FOR DAMAGE TO OR MALFUNCTION OF A KETT SHEAR HEAD USED IN COMBINATION WITH ANY DRILL OTHER THAN THOSE REGULARLY SUPPLIED BY US.